

**Core Fit Reference**

<b>0671</b>	Forroxcube:EFD20-***-****-S	Fair-Rite:89**202021	Magnetics:X-42020-EC
	Simens:EFD20/8/5	Ferrite intl:20-10-17	Micrometals:EF80-**

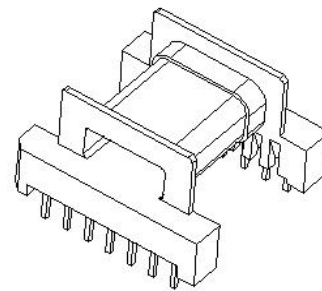
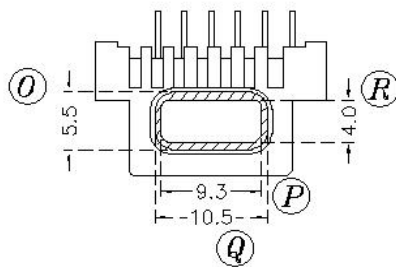
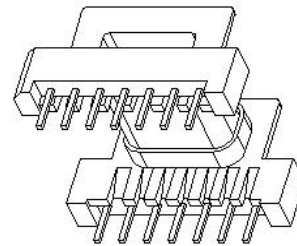
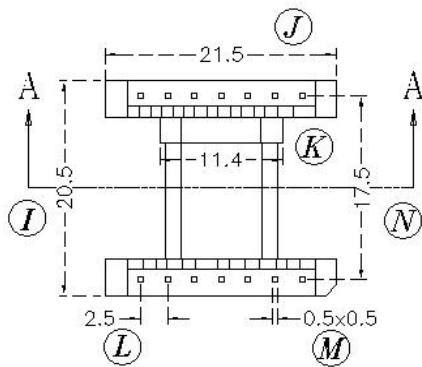
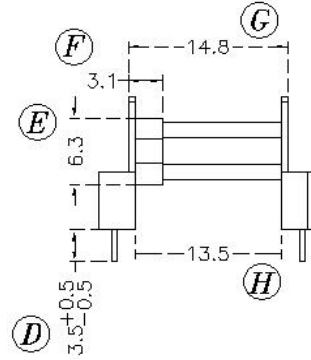
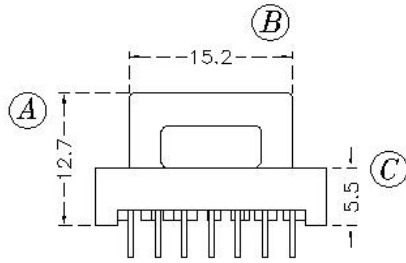
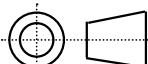

	Scale	Tolerance (mm)			Terminal Plating	Terminal Material	No of Terminals	
	None	0-4mm +/-0.1	4-16mm +/-0.2	16-60mm +/-0.3	100% Sn	CP Wire	14	

**LODESTONE PACIFIC**  
 **CHINA FACTORY**  
[www.lodestonepacific.com](http://www.lodestonepacific.com)

Molding Material	UL File No.	Rating	Class
PM-9820	E41429	UL94-V0	N
<b>Bobbin Part Number</b>			Rev No
<b>B-EFD20H-14-1-PH2</b>			<b>1</b>